

Post Office Engineering Department

TECHNICAL PAMPHLETS FOR WORKMEN

Subject :

Standard Graphical Symbols for Telegraphy, Telephony and Radio Communication.

ENGINEER-IN-CHIEF'S OFFICE,
July, 1934.

LONDON:
REPRINTED BY HIS MAJESTY'S STATIONERY OFFICE.

By permission of the British Standards Institution from British Standard No. 530, 1934, "Graphical Symbols for Telephony, Telegraphy and Radio Communication," official copies of which can be obtained from the Publications Department, British Standards Institution, 28, Victoria Street, S.W.1, price 2s. 3d. post free.

1934.

LIST OF Technical Pamphlets for Workmen

GROUP A.

1. Magnetism and Electricity.
2. Primary Batteries.
3. Technical Terms.
4. Test Boards.
5. Protective Fittings.
6. Measuring and Testing Instruments.
7. Sensitivity of Apparatus.
8. Standard List of Terms and Definitions used in Telegraphy and Telephony. (*Not on sale.*)
9. Standard Graphical Symbols for Telegraphy, Telephony and Radio Communication. (*Not on sale.*)

GROUP B.

1. Elementary Principles of Telegraphy and Systems up to Morse Duplex.
2. Telegraph Concentrators.
3. Wheatstone System. Morse Keyboard Perforators.
4. Quadruplex, Quadruplex Repeated Circuits and Telegraph Repeaters, Simplex and Duplex.
5. Hughes Type-printing Telegraph.
6. Baudot Multiplex Type-printing System.
7. Western Electric Duplex Multiplex. Murray Duplex Multiplex. Siemens and Halske Automatic Type-printing System.
8. Fire Alarm Systems.

GROUP C.

1. Wireless Transmission and Reception.
2. Interference with Reception of Broadcasting.

GROUP D.

1. Elementary Principles of Telephony.
2. Telephone Transmission. "Loading." Telephone Repeaters and Thermionic Valves.
3. Principles of Telephone Exchange Signalling.
4. Magneto Exchanges—Non-Multiple Type.
5. Magneto Exchanges—Multiple Type.
6. C.B.S. No. 1 Exchanges—Non-Multiple Type.
7. C.B.S. Exchanges—Multiple Type.
8. C.B. Exchanges—No. 9 Type.
9. C.B. Exchanges—No. 10 Type.
10. C.B. Exchanges—No. 12 Type.
11. C.B. Exchanges—22 Volts.
12. C.B. Exchanges—40 Volts.
13. Trunk Telephone Exchanges.
14. Maintenance of Manual Telephone Exchanges.
15. Telephone Testing Equipment.
16. Routine Testing for Manual Telephone Exchanges.

(Continued on page iii of Cover.)

Post Office Engineering Department

PW A9

STANDARD GRAPHICAL SYMBOLS FOR TELEGRAPHY, TELEPHONY AND RADIO COMMUNICATION.

This pamphlet is a reprint of the British Standards Institution's Publication No. 530—1934 entitled "British Standard Graphical Symbols for Telephony, Telegraphy and Radio Communication." These symbols have been adopted by the Post Office for use throughout the British Post Office Telegraph and Telephone Services, and must be used in all official correspondence, instructions, circulars, specifications, drawings, diagrams, etc.

CONTENTS.

	PAGE
Foreword	3
Guiding Principles to be observed in using Symbols ...	4
Section 1.—Telephones and Telegraphs	6
Section 2.—Radio Communication	22
Typical Schematic Circuit Diagram of Director <i>facing p.</i>	26
Index	27

CORRECTION SLIP TABLE.

Serial No. of Slip.	Date of Issue.	Corrections carried in	
		on date.	by (Initials).

FOREWORD.

In diagrams of electrical installations, apparatus and parts of apparatus cannot generally be conveniently represented in all their details. For this reason symbols have been created for practical purposes which represent the object in a simplified form and which make it possible to draw any diagram in a minimum of time whilst giving it all the desired clearness and a convenient size. In order that all branches of electro-technics may benefit by these advantages, however, it is desirable that these symbols should, as far as possible, convey the same meaning to all concerned. The object of the Committee, therefore, has been to draw up a British Standard List of Graphical Symbols which would be acceptable to the various needs of the appropriate sections of the electrical industry and, as far as possible, based upon symbols which have been internationally agreed.

This new edition of the British Standard Graphical Symbols for Telephones, Telegraphs and Radio Communication (formerly included in B.S. Specification No. 108—1922) is accordingly in conformity, to a large extent, with the list of symbols issued by the International Electrotechnical Commission (I.E.C. Publication 42—1931) and the recommendations of the International Consultative Committee on Long-distance Telephony.

In selecting and devising symbols, stress has been laid on the following points :—

- (a) Each symbol should as far as practicable be—
 - (i) Simple in form in order to facilitate drawing and to avoid loss of time.
 - (ii) Self-explanatory so as to avoid any confusion with other symbols.
 - (iii) In general use.
- (b) The symbols should include only characteristic elements. Combined symbols are, in general, not included.
- (c) The symbol should show *diagrammatically* the working of the part of the apparatus marked in the circuit.
- (d) The mechanical construction of the apparatus or part of the apparatus to be represented is of secondary importance. For instance, the same symbol is used for

all kinds of relays which *are used for the same purpose*, although the type of construction may be very different.

(e) All pictorial drawings should be avoided, as it should be remembered that the symbols are intended for diagrams of electrical circuits and not for guidance for construction of apparatus.

Motors, generators and other apparatus of a general character used in connexion with telephone, telegraph and radio installations should be represented by the corresponding symbols as given in British Standard No. 108, Graphical Symbols for General Electrical Purposes.

Guiding Principles to be observed in Using the Symbols.

NOTE.—The following guiding principles apply principally to the use of symbols in Section 1, Telephones and Telegraphs.

(a) In general, diagrams should be so drawn that in tracing-out the progress of a call they are read from left to right or from top to bottom.

(b) The "detached contact" system is recommended in showing schematic circuit arrangements. Under this system a relay is designated by a combination of a letter and a figure, e.g. H/3. The letter identifies the relay, and the figure shows the number of contact units. The contact units are shown thus:—H1, H2, H3.

Where a relay has more than one winding these should not be shown detached.

Keys may also be shown with their several contact units detached. Each contact unit should be designated by the key function followed by a figure/figure, e.g., Speak 1/3, Speak 2/3, Speak 3/3. The first figure is the identifying number of the contact unit, and the second figure is the total number of contact units associated with that function of the key.

(c) In key symbols, where the contact units are not detached, the lever and arrows to indicate the direction of the motion of the key are not normally shown, but if doubt exists as to the operation of contact units, the lever and arrows should be included.

Example :—

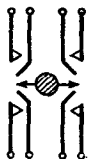

(d) Wires in contact should preferably not be shown

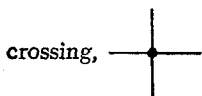

but should be shown thus











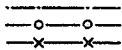



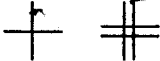
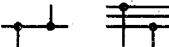





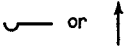





(e) Alternative symbols have been adopted to show the same apparatus where this is considered necessary to give clearness and simplicity according to the type of diagram under consideration, e.g., Symbol No. 114 (a) and No. 114 (f) in which the same piece of apparatus is shown in two different forms for circuit and trunking diagrams respectively.

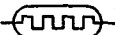















(f) The normal contact metal is silver. If any metal other than this is used, it should be designated on the drawing by the chemical symbol of the metal employed : e.g., Symbols Nos. 80 and 81.













(g) The application of these principles and the use of some of the symbols are illustrated in the diagram facing page 26.





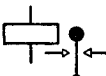





SECTION I.
TELEPHONES AND TELEGRAPHS.

No.	Description.	Symbol.
1	Direct Current.	D.C. or —
2	Alternating Current.	A.C. or ~
3	Circuit (General Symbol) <i>NOTE:— The thickness of the line varies according to the importance of the circuit.</i>	
4	Methods of showing alternative Circuit Connections.	
5	Jumper.	
6	Boundary Line.	
7	Insulation. <i>NOTE:— Hatching to be shown where possible, otherwise show solid.</i>	
8	Crossing of Conductors not in contact.	
9	Tappings. <i>NOTE:— Separate points for each tapping.</i>	
10	Common Point. (Indicates that several similar circuits are connected with a common source)	
11	U-point. (Jacking-in Point) Example of use. 	∨
12	Routiner Access Point. Example of use. 	∇
13	Variability (General Symbol)	
14	Sliding Contact. Example 1.  Example 2. 	

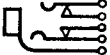

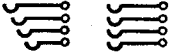
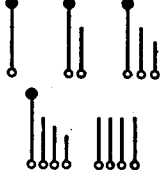



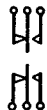





No.	Description	Symbol.
15	Terminal.	
16	Condenser.	
17	Variable Condenser.	
18	Resistor (General Symbol) Inductive or non-inductive.	
19	Resistor (Practically non-inductive for the purpose for which it is used.)	
20	Resistor, variable with sliding contact adjustment.	See No. 14
21	Ballast Resistor (Barretter)	
22	Inductor (General Symbol)	
23	Inductor with iron core.	
24	Telephone Receiver (General Symbol)	
25	Telephone Receiver, Bell type	
26	Microphone (Telephone Transmitter), General Symbol. <i>NOTE:— The vertical line represents the diaphragm; the circle represents the case.</i>	
27	Microtelephone (Combined Instrument)	
28	Microtelephone with switch.	
29	Telephone (General Symbol, for use on plans)	









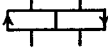

No.	Description.	Symbol.
30	Subscriber's Set (General Symbol)	
31	Subscriber's Set, Local Battery	
32	Subscriber's Set, Central Battery	
33	Subscriber's Set, Automatic	
34	Subscriber's Set, L. B. Magneto Calling	
35	Subscriber's Set, L. B. Buzzer Calling	
36	Subscriber's Set, L. B. Magneto and Buzzer Calling.	
37	Subscriber's Set, L. B. with Battery Calling	
38	Telephone Exchange (General Symbol)	
39	Telephone Exchange, Manual (General Symbol)	
40	Telephone Exchange, L. B. <i>NOTE: - The thickness of the line varies according to the importance of the installation</i>	
41	Telephone Exchange, C. B.	
42	Telephone Exchange, Automatic.	
43	Telephone Exchange, Semi-automatic (See also No 49)	
44	Telephone Exchange, Toll or Trunk	
45	Telephone Exchange, L. B. Magneto Calling	
46	Telephone Exchange, L. B. with Buzzer Calling	

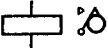

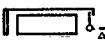

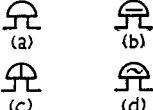







No.	Description.	Symbol.
47	Telephone Exchange, L.B with Magneto and Buzzer Calling	
48	Telephone Switchboard (General Symbol)	
49	Telephone Switchboard, Auto-manual	
50	Primary or Secondary Cell.	
51	Battery of Primary or Secondary Cells. Voltage to be shown where necessary. <i>NOTE:- Unless otherwise indicated the long line represents the positive pole and the short thick line the negative pole.</i>	
52	Earth.	
53	Ringing (General Symbol)	
54	Ringing Generator (General Symbols)	
55	Ringing Generator: Detailed form (Examples) <i>NOTE:- Spring contacts are varied according to circuit requirements</i>	
56	Vibrator, Ringing (Pole Reverser or Reed Converter)	
57	D.C. Generator	
58	A.C. Generator	
59	Voice-Frequency Generator.	
60	Transformer (General Symbol)	

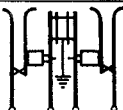







No.	Description	Symbol.
61	Transformer with 3 windings.	
62	Transformer with Iron Core.	
63	Screened Transformer.	
64	Jack (Simplified Symbol)	
65	Jack (General Symbol). Example of Break Jack 	
66	Jack, Multi-point <i>In certain circumstances, e.g. for convenience of diagram layout, the individual jack contacts may be shown detached</i>	
67	Plugs. <i>NOTE:- In the two or three-point plugs, the conductors may be shown in any order to facilitate drawing</i>	
68	Press-button, Make	
69	Press-button, Break	
70	Press-button, Make and Break	
71	Key, Non-locking (Example, Ringing Key)	





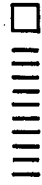



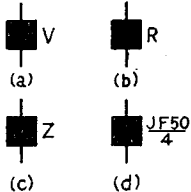

No.	Description.	Symbol
72	Key, Locking (Example, Speaking Key)	
73	Key, 3-position. Example (a) Ringing and Speaking Key. Example (b), Make-before-break Key.	
74	Gravity Switch <i>NOTE:- The arrangement of contacts may be varied. The contacts are shown in the normal position, i.e. with the receiver on the hook</i>	
75	Cradle Switch. <i>NOTE:- The arrangement of contacts may be varied. The contacts are shown in the normal position, i.e. with the microtelephone on the cradle</i>	
76	Interrupter	
77	Interrupter Springs	
78	Mechanically-operated Contacts Examples :- (a) Break. (b) Make. (c) Make-before-break. (d) Change-over.	
79	Relay Contacts. Examples :- (a) Break. (b) Make. (c) Make-before-break. (d) Change-over	

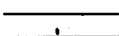
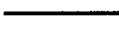
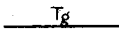
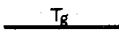
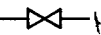

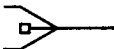











No.	Description	Symbol
80	Platinum Relay Contact. Example 	Pt.
81	Mercury Relay Contact Example 	Hg.
82	Relay Contact operated previous to remaining contact units on same relay. Example 	x
83	Relay Contact operated after the remaining contact units on same relay. Example. 	y
84	Relay Coil (General Symbol) <i>NOTE (1):- The resistance in ohms of the winding shall be inserted in the rectangle.</i> Example.  <i>NOTE (2):- The points at which the current enters and leaves the relay may be shown on the same side of the coil.</i>	
85	Relay Coil with non-inductive Shunt, whether wound on core or externally.	
86	Relay Coil, Slow Releasing.	
87	Relay Coil, Slow Operating.	
88	Relay Coil, Polarised <i>NOTE:- Arrow indicates direction of current to operate relay.</i>	
89	Relay Coil, Alternating Current <i>NOTE:- Frequency to be indicated if required</i> Example 	
90	Relay Coil, Shunt Field. <i>NOTE:- With current in direction of arrows, the relay does not operate. The reversal of either current causes the relay to operate</i>	





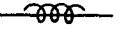
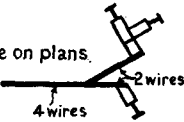





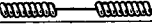



No	Description	Symbol
91	Relay Coil with 2 windings <i>NOTE:- Additional windings may be added</i>	
92	Relay Coils with 2 windings, Differential <i>NOTE:- With current in direction of arrows, the relay does not operate. The reversal of either current causes the relay to operate.</i>	
93	Relay Coil with Iron and Nickel Core, to give high impedance.	
94	Relay, Thermal type.	
95	Meter or Message Register (General Symbol) <i>NOTE:- The coil may be shown in accordance with one of the symbols for relay coils.</i>	
96	Indicator, Grid, Flag or Doll's Eye type (General Symbol)	
97	Indicator, Grid, Flag or Doll's Eye type, with Alarm Contact.	
98	Indicator, Drop <i>NOTE:- The coil may be shown in accordance with one of the symbols for relay coils.</i>	
99	Lamp, Signal or Resistance.	
100	Bell :- (a) General Symbol. (b) D.C. (c) Single-stroke (d) A.C.	
101	Buzzer :- (a) General Symbol. (b) D.C. (c) A.C.	
102	Cut-out, (Fuse), General Symbol.	
103	Cut-out, (Fuse) with Alarm Contact. Example of Alarm Fuse with Bus-bar and Alarm-bar	
104	Heat Coil, Compression type Example of use	

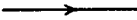



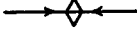
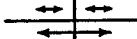
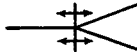
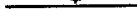







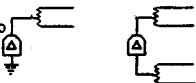

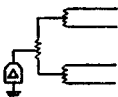

No.	Description	Symbol
105	Heat Coil, Break type Example of use 	
106	Lightning Protector for 1 Wire (General Symbol)	
107	Lightning Protector between 2 Wires and Earth.	
108	Lightning Protector, Vacuum type	
109	Combined Heat Coil and Protector with Testing Facilities	
110	Combined Heat Coil and Protector	
111	Metal Rectifier <i>NOTE:- The direction of conductivity is from the triangle to the plate</i>	
112	Dial, simple Form	
113	Dial, detailed Form. Example.	
114	Selector (General Symbols) (a) Uniselector, Non-bridging Wiper	For Circuit Diagrams  For Trunking Diagrams. 
	(b) Uniselector, Bridging Wiper	For Circuit Diagrams. 















No.	Description.	Symbol.
114	Selector. (General Symbols) contd. (c) Unselector, Non-bridging Wiper Indicates that a pair of wipers pass consecutively over two arcs of the bank.	For Circuit Diagrams. 
	(d) Unselector, Homing Arc. Indicates that a double metal segment is used	For Circuit Diagrams. 
	(e) Unselector, Homing Arc. Indicates that: (i) The bank contacts are commoned, or (ii) A solid metal segment is used	For Circuit Diagrams. 
	(f) Two-motion Selector. Non-bridging Wiper	For Circuit Diagrams.  For Trunking Diagrams. 
	(g) Two-motion Selector Bridging Wiper.	For Circuit Diagrams. 
	(h) Two-motion Selector. Two wipers, side by side (Used on P.B.X. arc)	For Circuit Diagrams. 
	(j) Auxiliary Bank and Wipers.	





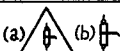
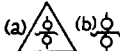







No	Description	Symbol.
115	Magnets :- (a) Vertical (b) Rotary (c) Release (d) Uniselector <i>NOTE (1) :- When contacts are operated as a result of the energisation of the magnet, the number of contact actions should be indicated below the magnet letter.</i> (2) :- <i>JF50</i> indicates that the selector is used as a Junction Finder and has 50 outlets using 4 wipers or 4 pairs of wipers as determined by the symbol used for the uniselector	
116	Relay Set (General Symbol)	For Trunking Diagrams 
117	Telephone Circuit or Route for Internal Traffic.	
118	Telephone Circuit or Route for International Traffic.	
119	Telegraph Circuit or Route for Internal Traffic.	
120	Telegraph Circuit or Route for International Traffic.	
121	Amplifier or Valve Repeater. <i>NOTE:- The apex of the triangle indicates the direction of transmission.</i> Examples of use :- (a) 2-wire  (b) 4-wire 	
122	Terminating Set with Balance.	
123	(a) Artificial Line (General Symbol)	
	(b) Alternative symbol for single-wire circuit.	
124	Balancing Network.	
125	Filter (General Symbol)	
126	Filter, High-pass <i>NOTE:- Cut-off Frequencies indicated thus:-</i> 	

No.	Description.	Symbol.
127	Filter, Low-pass.	
128	Filter, Band-pass. <i>NOTE:- Cut-off Frequencies indicated thus:-</i>	 
129	Echo Suppressor. Example of use in a 4-wire repeater:-	 
130	Loading Coil with Musical Loading. <i>NOTE:- Cut-off not less than 6,400~ rising to 10,000~ if possible.</i> Example of use	 
131	Loading Coil with Extra-light Loading <i>NOTE:- Cut-off of side circuit not less than 5,800~. Cut-off of phantom circuit not less than 6,000~.</i>	
132	Loading Coil with Medium-heavy Loading <i>NOTE:- Cut-off of side and phantom circuit not less than 2,900~.</i>	
133	Continuous Loading. Example of use	 
134	Circuits on Aerial Lines (a) Single Wire. (b) 2 or more wires. Example of use on plans.	 (a)  (b) 
135	Tee'd Wires. Single Wire	
136	Circuits in Cables. (a) Underground Single Wire. 2 or more wires. <i>NOTE:- This symbol also applies to cables attached to the walls of tunnels, ecc.</i>	











No.	Description.	Symbol
136	Circuits in Cables contd. (b) Submarine and Submerged Cables Example. 	
	(c) Aerial Cable.	
137	Testing Points (a) Office or Test Hut Example  } Ccts. led in. } Ccts. not led in.	
	(b) Test Box on Pole Example  } Ccts. led in } Ccts. not led in	
138	Telegraph Circuit, Single Direction	
139	Telegraph Circuit, Both Directions.	
140	Telegraph Circuit Duplex (General Symbol)	
141	Telegraph Circuit, Duplex, Differential	
142	Telegraph Circuit, Duplex, Bridge	
143	Telegraph Circuit, in Echelon	
144	Telegraph Circuit, in Forked Echelon.	
145	Telegraph Circuit, Single-current	 or 
146	Telegraph Circuit, Double-current	
147	Telegraph Circuit, Audio or Voice Frequency	
148	Telegraph Circuit, Superaudio Frequency	





No	Description	Symbol.
149	Telegraph Circuit, Subaudio Frequency	
150	Telegraph Circuit, Phantom. Example of circuit to which symbol refers.	 
151	Telegraph Circuit, Double Phantom. Example of circuit to which symbol refers.	 
152	Telegraph Set. (a) General Symbol. (b) Audio or Voice Frequency (c) Superaudio Frequency. (d) Subaudio Frequency.	 (a)  (b)  (c)  (d)
153	Correcting Network.	
154	Relay, Telegraph (General Symbol)	
155	Relay, Telegraph, Differential.	
156	Relay, Telegraph, with several windings.	
157	Relay, Telegraph, Biassed.	
158	Relay, Telegraph, with three positions.	
159	Relay, Telegraph, Vibrating	





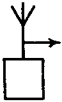
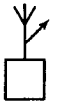
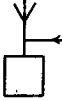



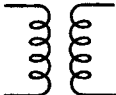

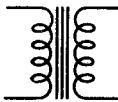
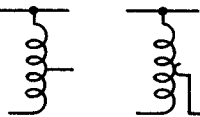
No	Description	Symbol.
160	Relay, Telegraph, Moving Coil	
161	Key, Single-current.	
162	Key, Telegraph, Reversing	
163	Transmitter, Telegraph (General Symbol)	
164	Transmitter, Baudot, Manual.	
165	Transmitter, Keyboard	
166	Transmitter, Tape.	
167	Transmitter, Telegraph, Photographic.	
168	Receiver, Telegraph.	
169	Receiver, Telegraph, Morse	
170	Siphon Recorder. (a) Schematic. (b) For use on plans.	
171	Undulator. (a) Schematic. (b) For use on plans.	
172	Receiver, Telegraph, Perforating	
173	Receiver, Telegraph, Tape Printing	
174	Receiver, Telegraph, Column Printing	
175	Receiver, Telegraph, Picture	







No.	Description.	Symbol.
176	Distributor Telegraph, (General Symbol)	
177	Distributor, Telegraph, 2 Channels.	
178	Distributor, Telegraph, 3 Channels.	
179	Telegraph, Baudot	
180	Telegraph, Hughes	
181	Teleprinter	
182	Repeater, Telegraph, Simplex.	
183	Repeater, Telegraph, Duplex.	
184	Repeater, Telegraph, Regenerative.	
185	Re-transmitter	
186	Galvanometer (General Symbol)	
187	Galvanometer, Differential. <i>NOTE: - The windings may be varied to suit requirements.</i>	



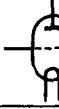
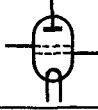

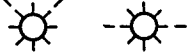

SECTION 2.
RADIO COMMUNICATION.

No.	Description.	Symbol.
201	Aerial (General Symbol)	
202	Frame Aerial (General Symbol)	
203	Counterpoise (General Symbol)	
204	Transmission (General Symbol)	
205	Reception (General Symbol)	
206	Wireless Station (General Symbol)	
207	Wireless Station, Transmitting <i>NOTE:- For a Wireless Telephone Station, the symbol for a microphone (No. 26) —  — should be inserted in the square.</i>	
208	Wireless Station, Receiving	
209	Wireless Station, Transmitting and Receiving	

No.	Description.	Symbol.
210	Direction - finding Station.	
211	Wireless Station, Directional Transmission, Fixed direction.	
212	Wireless Station, Directional Transmission, variable direction.	
213	Wireless Station, Directional Reception, fixed direction.	
214	Wireless Station, Directional Reception, variable direction.	
215	Variable Condenser.	
216	Neutrodyne Condenser.	
217	Differential Condenser.	
218	Transformer, air-core.	

No.	Description.	Symbol.
219	Transformer, iron-core	
220	Auto-transformer, air-core	
221	Telephone Receiver, headgear-type.	
222	Screen (General Symbol)	
223	Poulsen Arc. <i>NOTE:- The carbon electrode is shown black</i>	
224	Rectifier (General Symbol)	
225	Detector (General Symbol)	
226	Anode.	
227	Grid.	
228	Cathode, incandescent - Filament	
229	Cathode, indirectly - heated	
230	Cathode, photo-electric or radio-active.	

No.	Description.	Symbol.
231	Diode.	
232	Triode.	
233	Tetrode.	
234	Triode, indirectly-heated.	
235	Screened Grid Valve, indirectly-heated.	
236	Pentode, indirectly-heated.	
237	Photo-electric Cell.	
238	Spark-gap.	
239	Multiple Spark-gap.	
240	Rotary Spark-gap	

No.	Description.	Symbol.
241	Loud-speaker	
242	Thermo-couple , indirectly-heated	
243	Thermo-couple , directly - heated	
244	Piezo- electric Crystal	
245	Gramophone Pick-up	
246	Gramophone Pick-up with hum- suppressor	
247	Electrolytic Condenser. <i>NOTE:- The + and - signs may be omitted if no ambiguity as to polarity will result.</i>	

TYPICAL SCHEMATIC CIRCUIT DIAGRAM OF DIRECTOR.

from A Digit. Selector

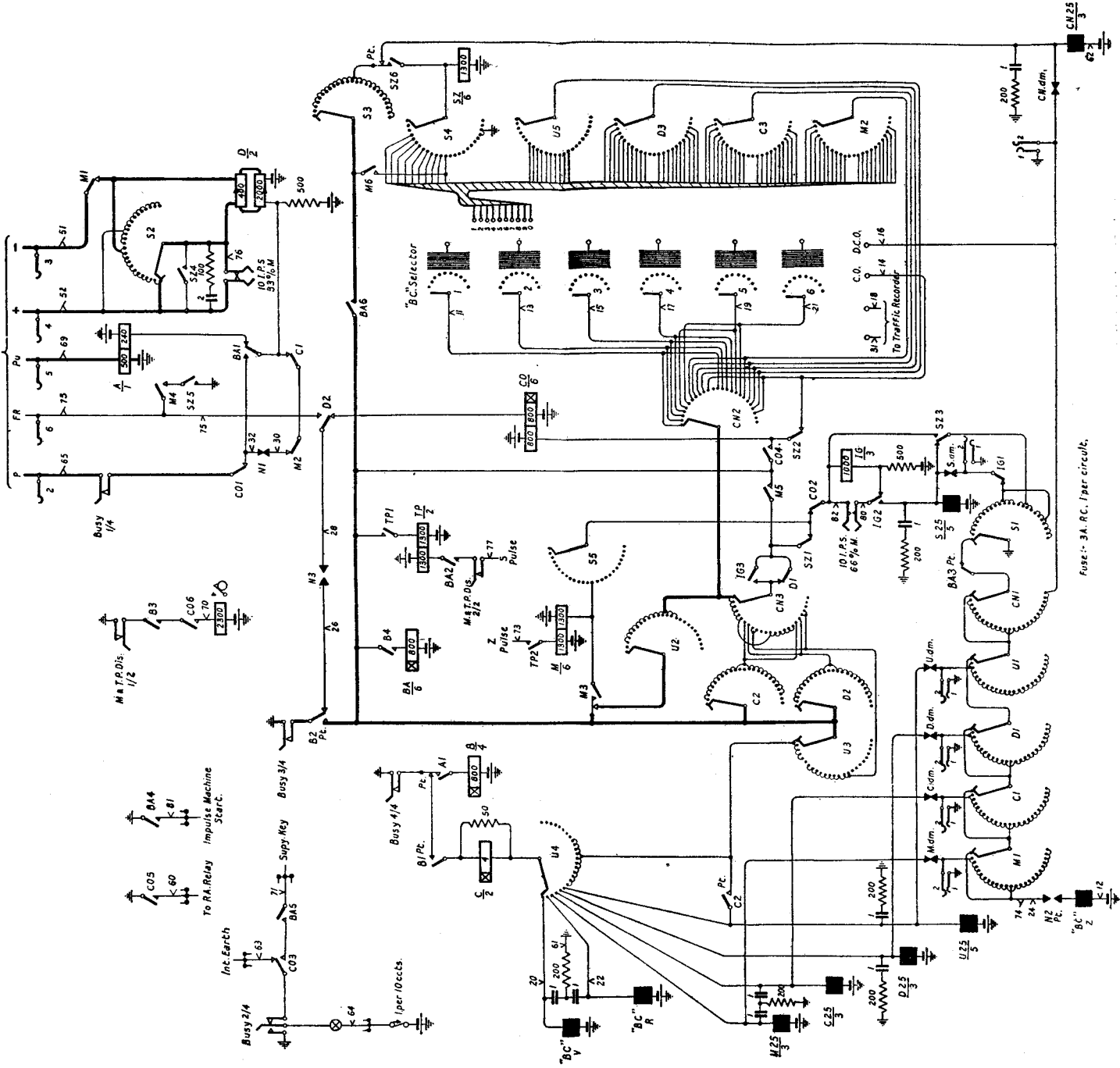

ALPHABETICAL INDEX.

Symbol.	Page	Symbol.	Page
A.C. generator	9	Contact, sliding	6
Aerials (radio)	22	Contacts, relay	11, 12
Aerial cable	18	Correcting network	19
— lines	17	Counterpoise	22
Alternating current... ..	6	Cradle switch	11
Amplifier	16	Crossing of conductors	6
Anode	24	Crystal, piezo-electric	26
Arc, Poulsen... ..	24	Cut-outs	13
Artificial line	16		
Balancing network	16	D.C. generator	9
Ballast resistor	7	Detector	24
Band-pass filter	17	Dial	14
Bank, auxiliary	15	Differential condenser	23
Barretter	7	Diode... ..	25
Battery	9	Direct current	6
Baudot telegraph	21	Direction-finding station	23
—transmitter	20	Distributors, telegraph	21
Bells	13	Double phantom circuit	19
Boundary line	6	Duplex repeater	21
Buzzers	13	—telegraph circuit	18
Cable, aerial	18	Earth... ..	9
—, submarine	18	Echo suppressor	17
Cables, circuits in	17	Electrolytic condenser	23
Cathode	24	Exchanges, telephone	8
Cell, primary	9		
—, secondary	9		
Circuit (general symbol)	6		
— connexions	6		
Circuit, telegraph	18	Filters	16, 17
Circuits, in cables	17	Frame aerial... ..	22
— on aerial lines	17	Fuses... ..	13
Coil, heat, break type	14		
—, heat, compression type	13		
—, loading	17		
Coils, relay	12, 13		
Common point	6		
Condenser	7	Galvanometer	21
—, differential	23	Generator, A.C.	9
—, electrolytic	26	—, D.C.	9
—, neutrodyne	23	—, ringing	9
—, variable	23	—, voice-frequency	9

Symbol.	Page	Symbol.	Page
Gramophone pick-up ...	26	Microtelephone ...	7
Gravity switch ...	11	Multiple spark-gap ...	25
Grid ...	24		
Heat coil, break type ...	14	Network, balancing ...	16
—coil, compression type	13	—, correcting ...	19
High-pass filter ...	16	Neutrodyne condenser ...	23
Hughes telegraph ...	21		
		Pentode ...	25
Indicators ...	13	Phantom circuit ...	19
Inductor ...	7	Photo-electric cell ...	25
Insulation ...	6	Piezo-electric crystal ...	26
Interrupter ...	11	Pick-up, gramophone ...	26
— springs...	11	Plug ...	10
		Poulsen arc ...	24
Jack ...	10	Press-buttons ...	10
Jacking-in point ...	6	Primary cell ...	9
Jumper ...	6	Protector, lightning...	14
Key, locking ...	11	Receiver, telephone ...	7
—, non-locking ...	10	— (telephone), headgear	24
Keys, telegraph ...	20	type ...	24
		Receivers, telegraph ...	20
Lamps ...	13	Reception (radio), general	22
Lightning protectors ...	14	symbol ...	22
Line, artificial ...	16	Recorder, siphon ...	20
Loading coils ...	17	Rectifier ...	24
Loading, continuous ...	17	Rectifier, metal ...	14
Loudspeaker... ..	26	Register, message ...	13
Low-pass filter ...	17	Relay coils ...	12, 13
		— contacts ...	11, 12
Magnets ...	16	— set ...	16
Message register ...	14	Relays, telegraph ...	19
Metal rectifier ...	14	—, thermal type ...	13
Meter... ..	13	Repeater, duplex ...	21
Microphone ...	7	—, regenerative ...	21
		—, simplex ...	21
		—, valve ...	16
		Resistance lamp ...	13
		Resistor ...	7
		Re-transmitter ...	21
		Ringin (general symbol) ...	9
		— generator ...	9
		— key ...	10
		— vibrator ...	9
		Rotary spark-gap ...	25

Symbol.	Page	Symbol.	Page
Routes, telegraph ...	16	Telegraph, Baudot ...	21
—, telephone ...	16	—, Hughes ...	21
Routiner access point ...	6	Telephone (general symbol)	7
		— exchanges ...	8
Screen (general symbol) ...	24	— receiver ...	7
Screened transformer ...	10	— receiver, headgear type	24
Secondary cell ...	9	— routes ...	16
Selectors ...	14, 15	— switchboard ...	9
Set, relay ...	16	— transmitter ...	7
—, subscriber's ...	8	Teleprinter ...	21
—, telegraph ...	19	Tetrode ...	25
—, terminating ...	16	Terminal ...	7
Signal lamp ...	13	Terminating set ...	16
Siphon recorder ...	20	Test box on pole ...	18
Simplex telegraph repeater	21	Testing points ...	18
Sliding contact ...	6	Thermal-type relay ...	13
Spark-gap ...	25	Thermo-couple ...	25
Springs, interrupter ...	11	Transformers ...	9, 23
Stations (radio) ...	22, 23	Transmission (radio) ...	22
—, direction-finding ...	23	Triode ...	25
Submarine cable ...	18		
Subscriber's sets ...	8	U -point ...	6
Suppressor, echo ...	17	Undulator ...	20
Switchboard, telephone ...	9	Uniselector ...	15
Switches ...	11		
		Valve repeater ...	16
Tappings ...	6	Valves ...	25
Teed wires ...	17	Variability (general symbol)	6
Telegraph circuits ...	18	Vibrator, ringing ...	9
— distributors ...	21	Voice-frequency generator ...	9
— receivers ...	20		
— relays ...	19	Wipers ...	15
— repeaters ...	21	Wireless stations ...	22, 23
Telegraph routes ...	16	Wires, teed ...	17
— set ...	19		
— transmitters ...	20		

LIST OF Technical Pamphlets for Workmen

(Continued)

GROUP D—Continued.

17. Internal Cabling and Wiring.
18. Distribution Cases, M.D.F. and I.D.F.
19. Cord Repairs.
20. Superposed Circuits. Transformers. Bridging Coils and Retardation Coils.
21. Call Offices.

GROUP E.

1. Automatic Telephony : Step by Step Systems.
2. Automatic Telephony : Coder Call Indicator (C.C.I.) Working.
3. Automatic Telephony : Keysending " B " positions.

GROUP F.

1. Subscribers' Apparatus. Common Battery System.
2. Subscribers' Apparatus, C.B.S. Part I—C.B.S. No. 1 System.
3. Subscribers' Apparatus. Magneto.
4. Private Branch Exchanges—Common Battery System.
5. Private Branch Exchange—C.B. Multiple No. 9.
6. Private Branch Exchanges—Magneto.
7. House Telephone Systems.
8. Wiring of Subscribers' Premises.

GROUP G.

1. Maintenance of Secondary Cells.
2. Power Plant for Telegraph and Telephone Purposes.
3. Maintenance of Power Plant for Telegraph and Telephone Purposes.
4. Telegraph Battery Power Distribution Boards.

GROUP H.

1. Open Line Construction, Part I.
2. Open Line Construction, Part II.
3. Open Line Maintenance.
4. Underground Construction, Part I—Conduits.
5. Underground Construction, Part II—Cables.
6. Underground Maintenance.
7. Cable Balancing.
8. Power Circuit Guarding.
9. Electrolytic Action on Cable Sheaths, etc.
10. Constants of Conductors used for Telegraph and Telephone purposes.

GROUP I.

1. Submarine Cables.

GROUP K.

1. Electric Lighting.
2. Lifts.
3. Heating Systems.
4. Pneumatic Tube Systems.
5. Gas and Petrol Engines.